

36

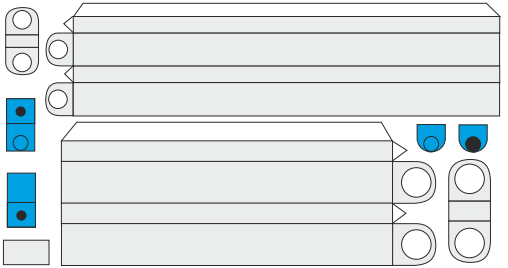

35

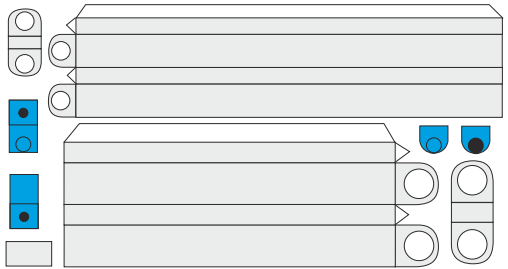

34

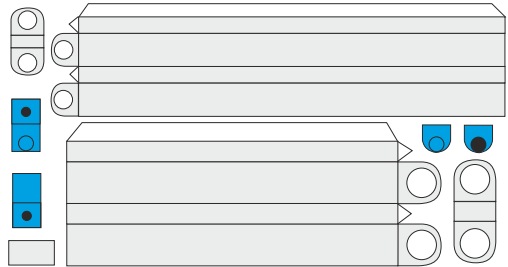

33

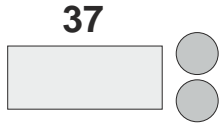

37

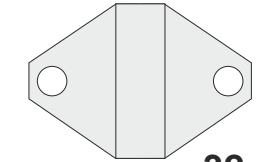

32

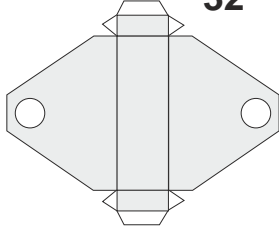

31



37

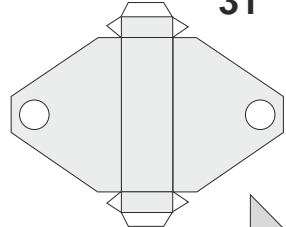
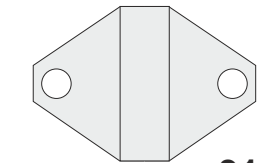

38

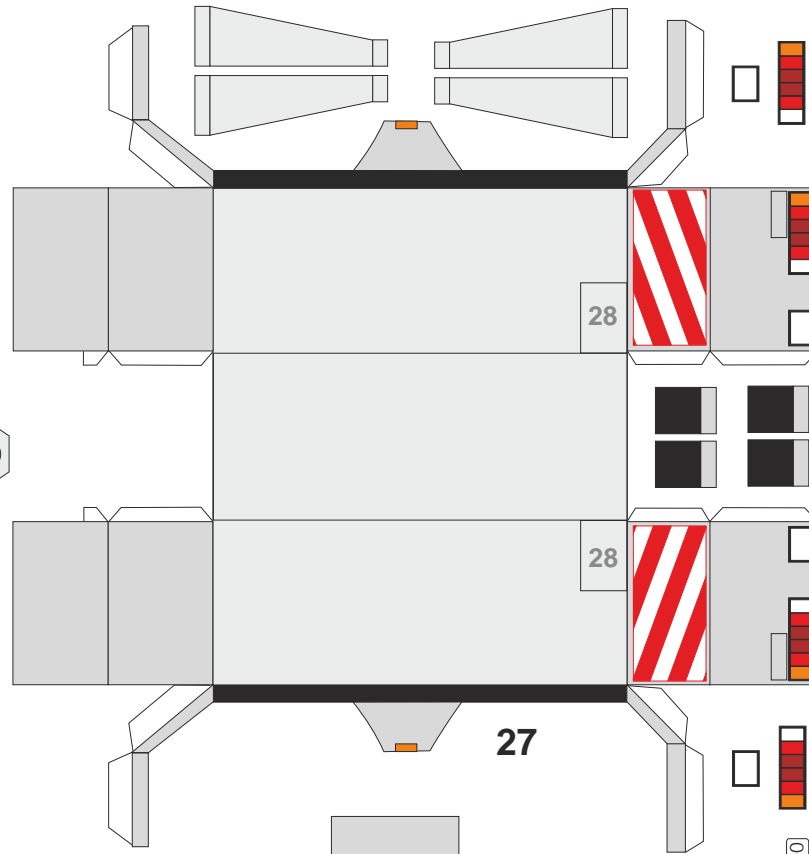
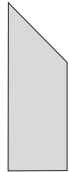

28

28

27

HB*PD 100

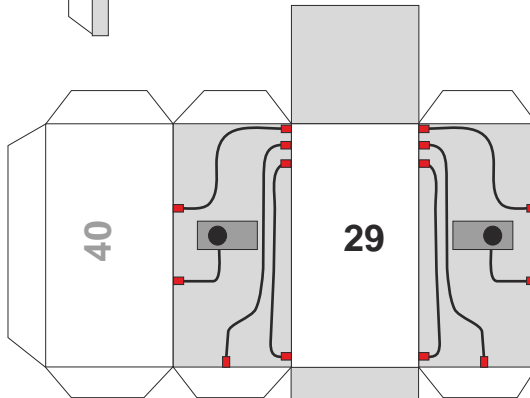

40

29

28

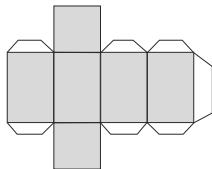

28

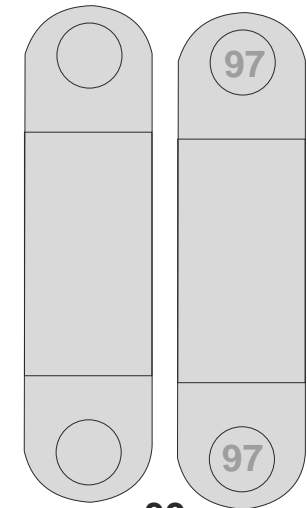
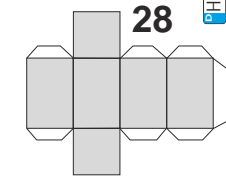

97

97

39

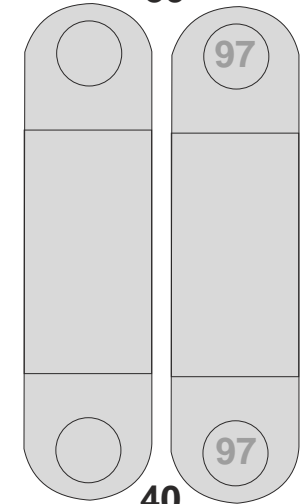

97

97

40



40



97

97

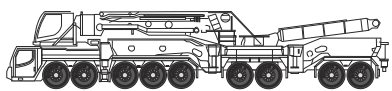

(C) PreDes 2009

007

only for
streetpaper.de

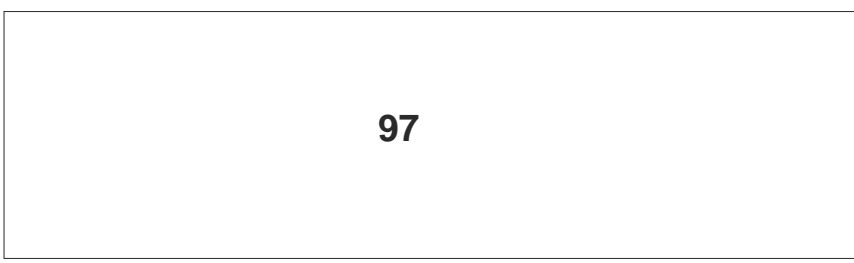
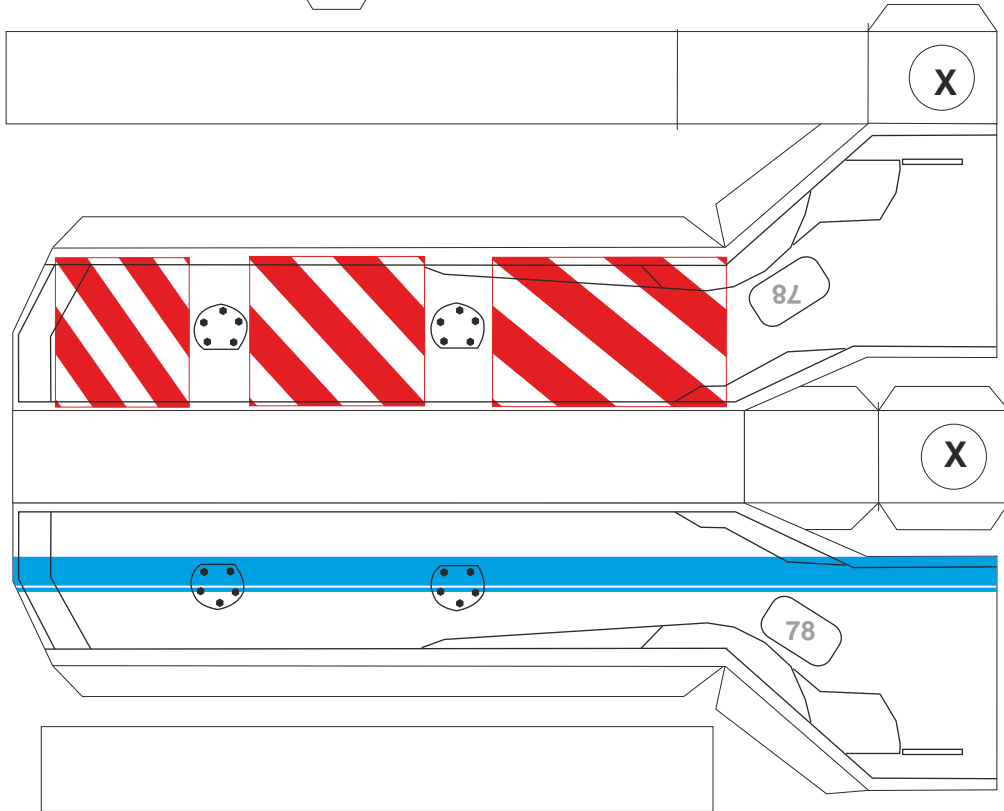
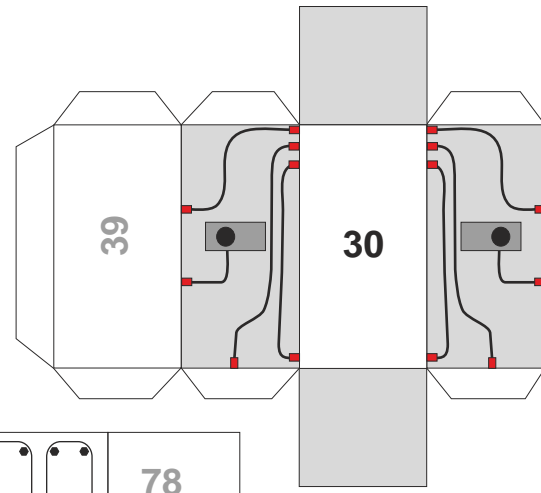
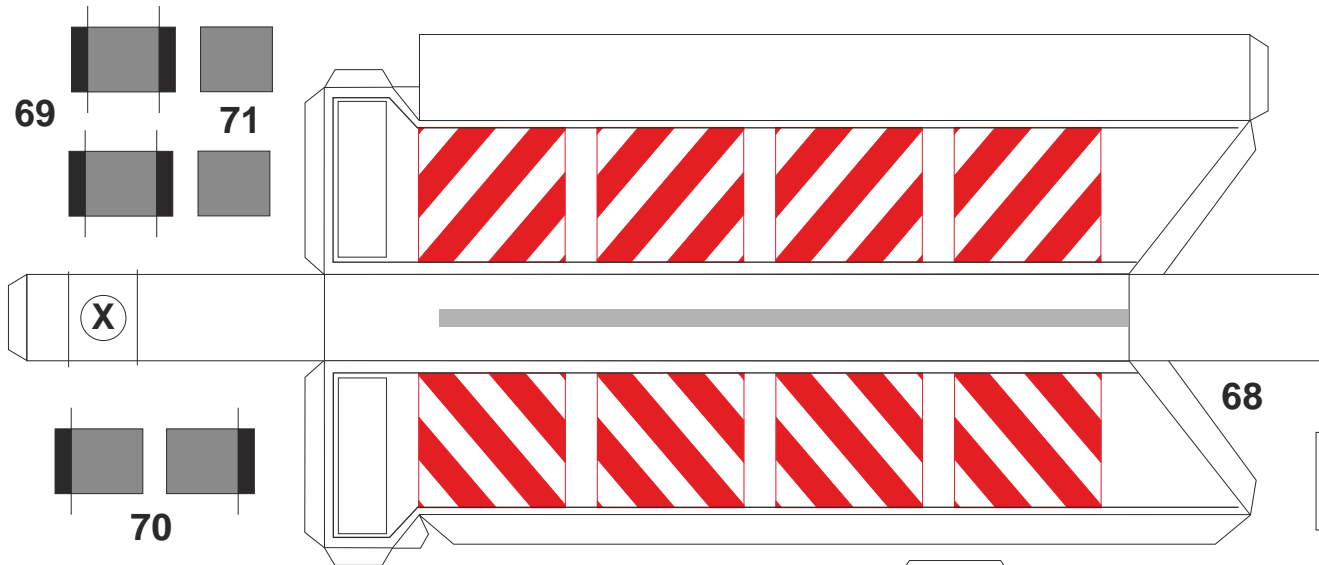

*only for
streetpaper.de*

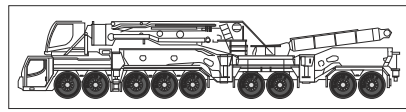

(C) PreDes 2009
008

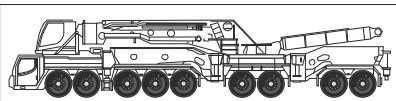
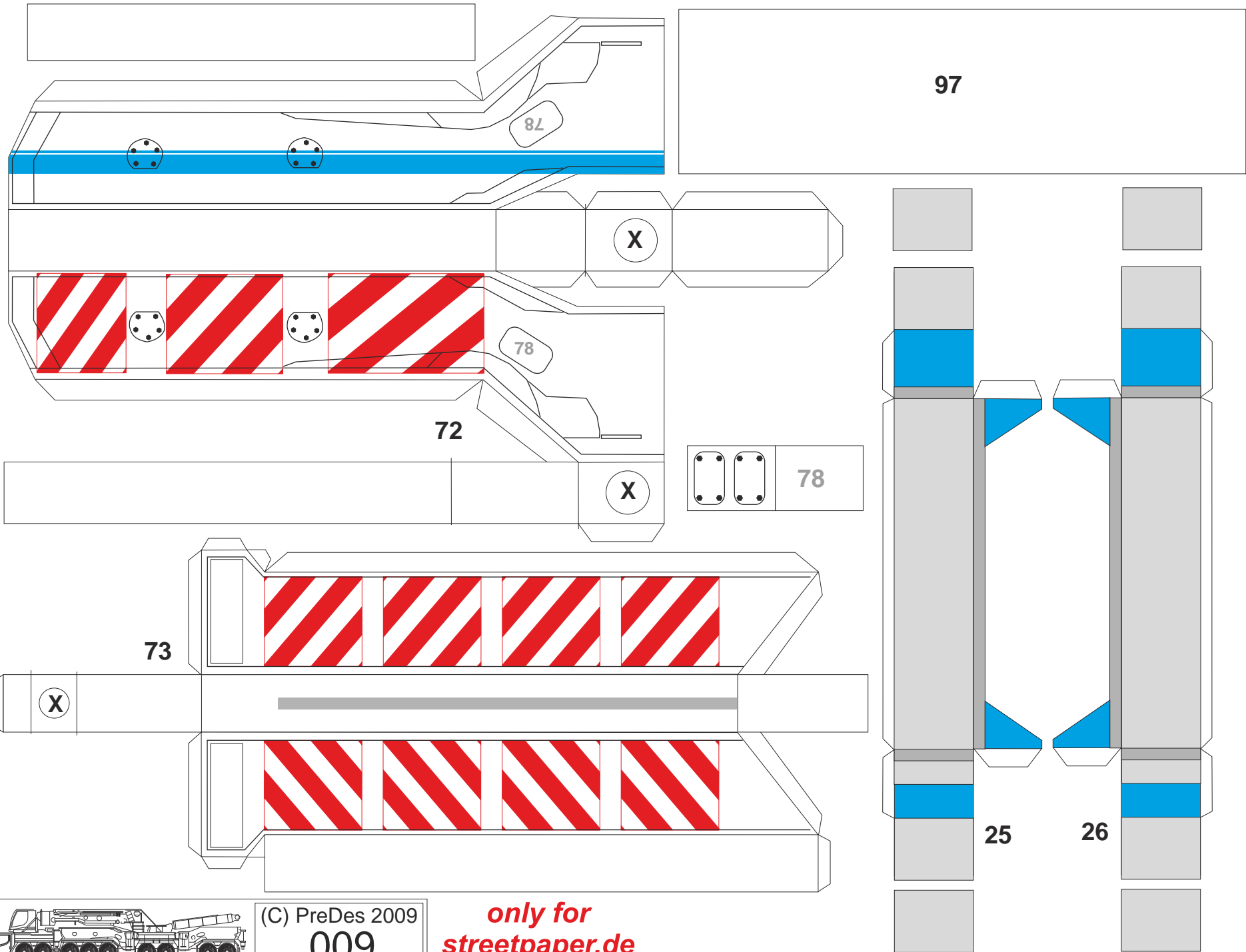

(C) PreDes 2009
009

only for
streetpaper.de

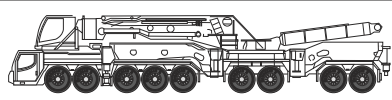

(C) PreDes 2009

011

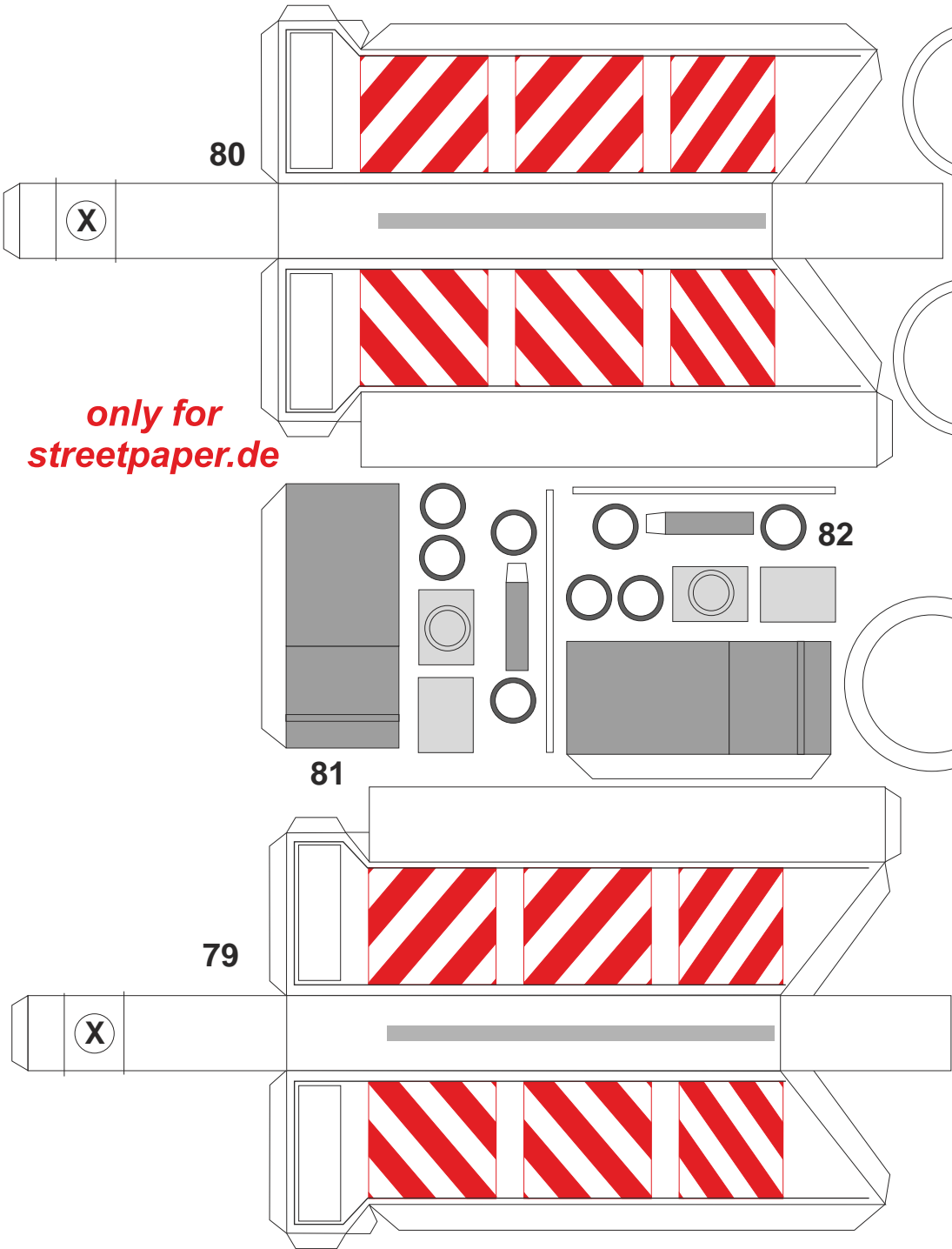

only for
streetpaper.de

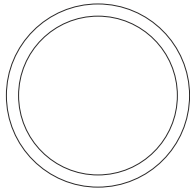

45

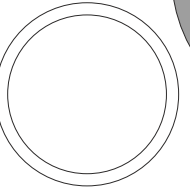

46

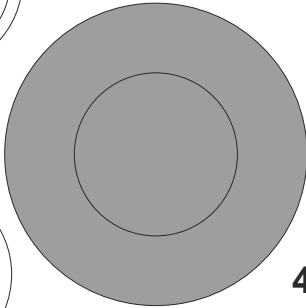

43

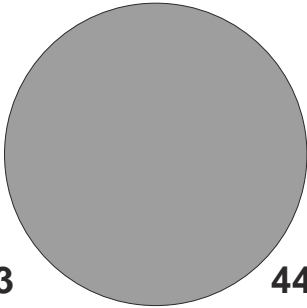

44

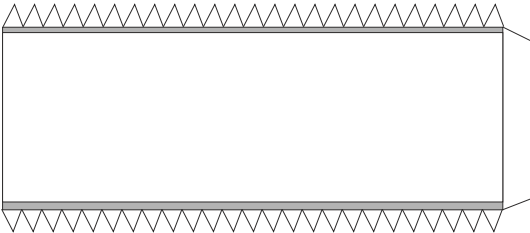

42

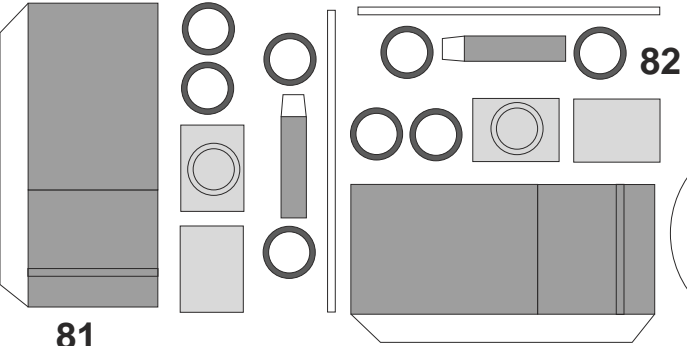

81

82

47

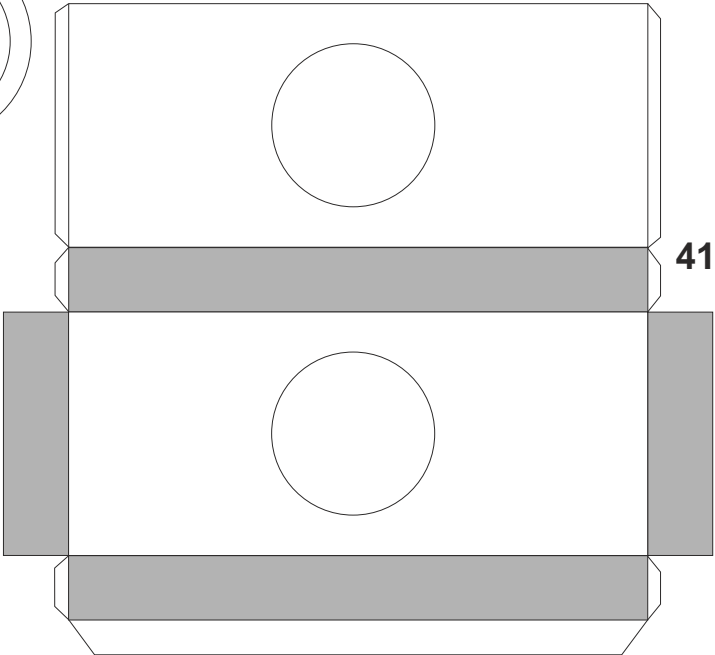
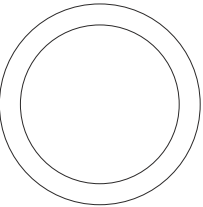

41

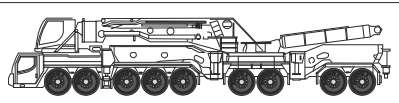

(C) PreDes 2009
012

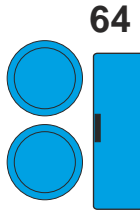

64

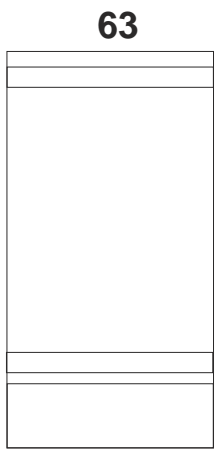
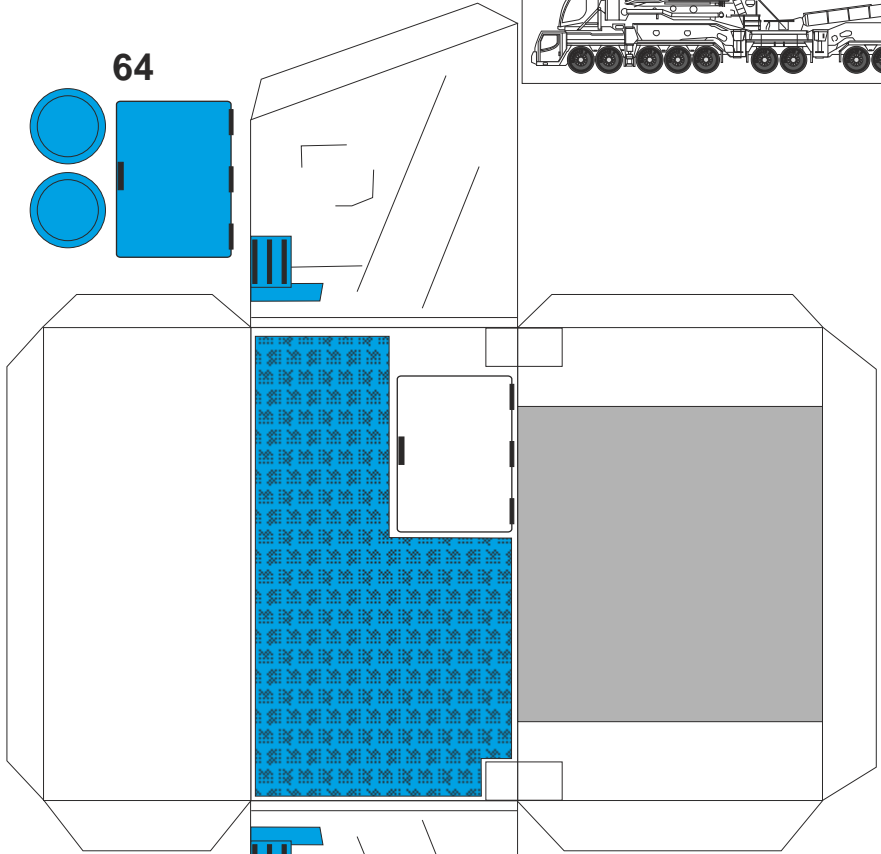

63

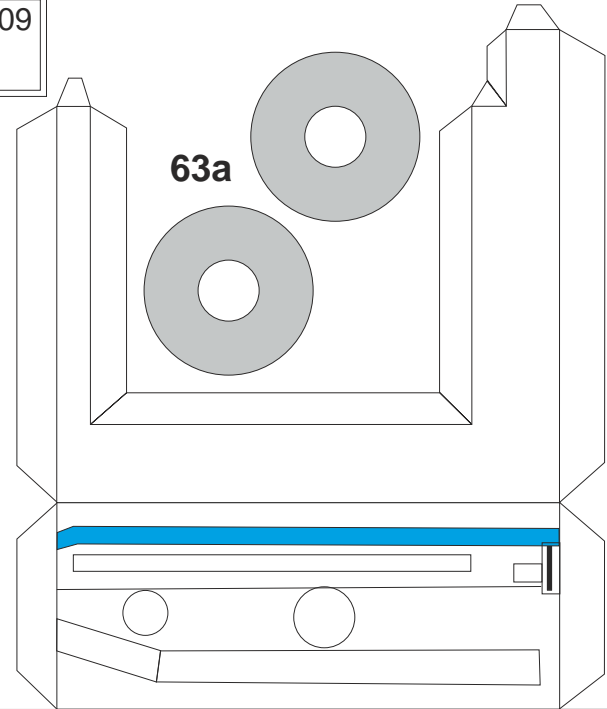

63a

63d

63a



66

60

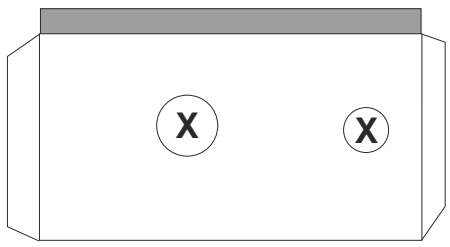

X

X

65

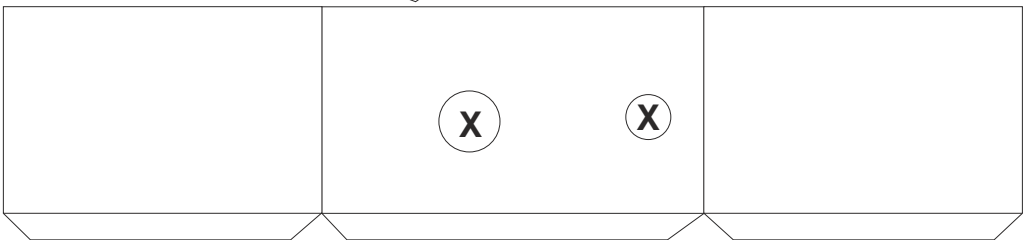

X

X

62

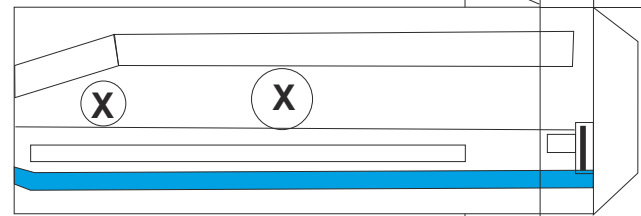

X

X

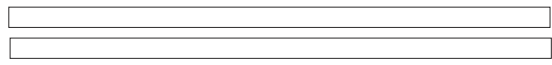

63c

*only for
streetpaper.de*